

Multi drum turner on fully powered Logiflex – flexible drum handling!

High flexibility and efficiency - the Multi drum turner can handle many kinds of drums in the horizontal or vertical position, and of different materials and dimensions: Steel, plastic, small, low, high, square, round drums – no problem!

Rotation and opening/closing of the gripping arms is electric. Propulsion as well as lifting and lowering is electric on the Multi drum turner fitted on the fully powered Logiflex.

The Multi drum turner has a set of flexible, specially designed grippers, which can be adjusted according to drum type/diameter. The grippers can, without tools, easily be adjusted to fit large and small drums.

Focus on safety – the drums are fixed by flexible grippers, locking plate and top lock.

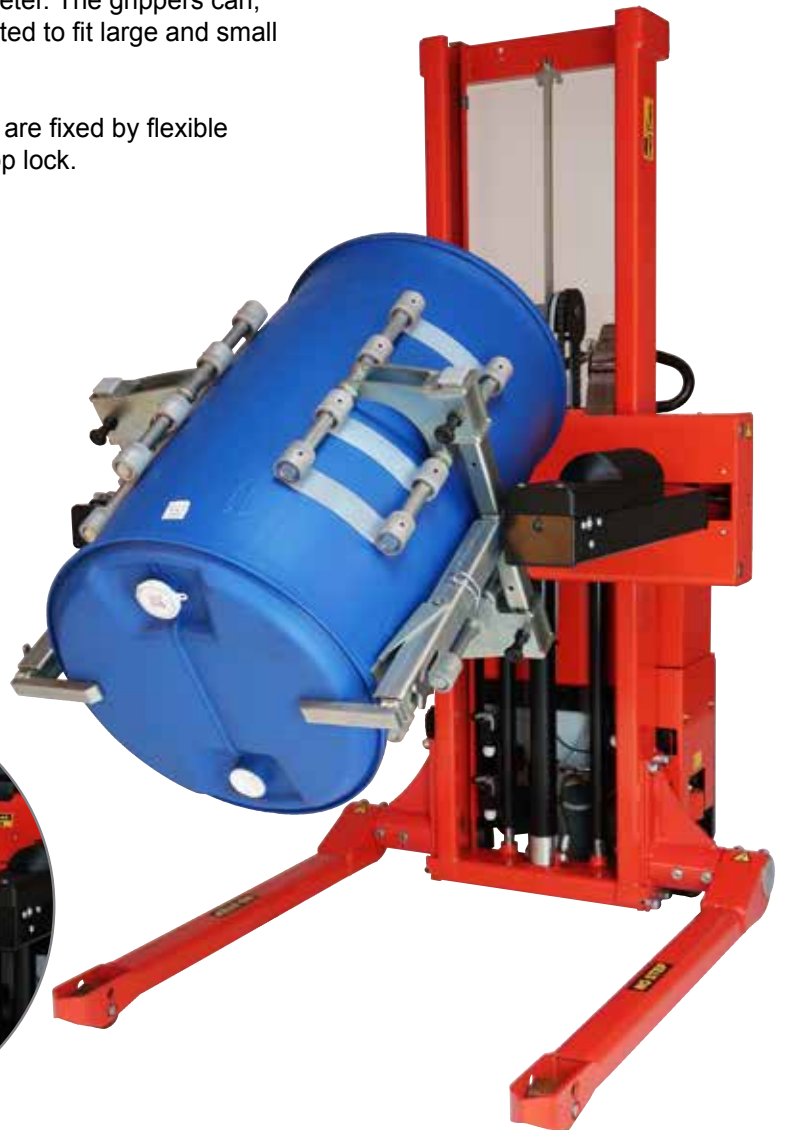
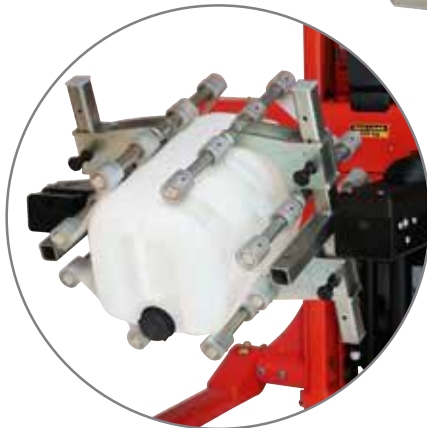
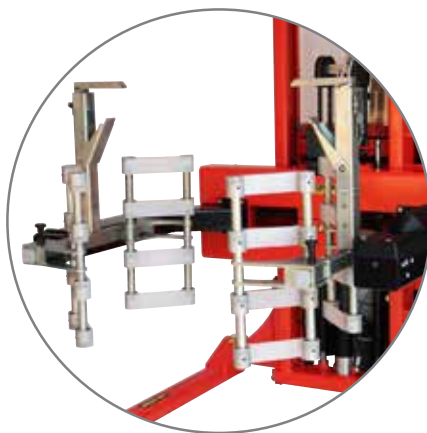

Technical Specifications

Electric propulsion, electric rotation and electric opening/closing of the gripping arms

- Handles steel and plastic drums from Ø300 to Ø600
- Straddle model increases the stability when handling the largest drums



Steel, plastic, small, low, high, square, round drums – no problem!

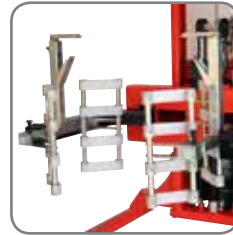

Flexible, specially designed gripping arms can be adjusted to various drum types.



Remote control for rotation, lifting/lowering and clamping.

Product (measured in mm)	SELFMDT	SELFMDT	SELFSDMT	SELFSDMT
Capacity in kg	350	350	350	350
Drum diameter	Ø300 to Ø600			
Lifting height	1800	2100	1800	2100
Rotation function	360°			
Overall height	1930	2240	1930	2240
Overall width	1000		166 + b ₄	
Overall width arms min.	775		775	
Overall width arms max.	1350		1350	
Length without carriage	605		605	
Overall length	1830		1830	
Lowered height	400		400	
Width between legs	316	316	850 - 942, 942 - 1124, 1124 - 1306, 1240-1422	
Run-in length	1100		1100	
Turning angle of the wheels	210°			
Driving motor	1,2 kW 24 V speed control electronically variable			
Driving speed with/without load	Below 500 mm lift: 5/6 km/h, over 500 mm lift: 3/4 km/h			
Pump motor	1,2 kW 24 V			
Lifting speed with/without load	0,07/0,12 m/s			
Lowering speed with/without load	0,12/0,07 m/s			
Weight in kg (no battery)	500	508	540	548

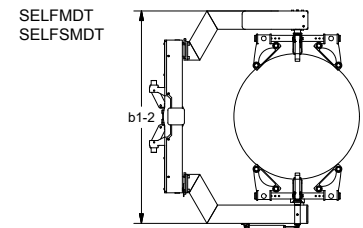
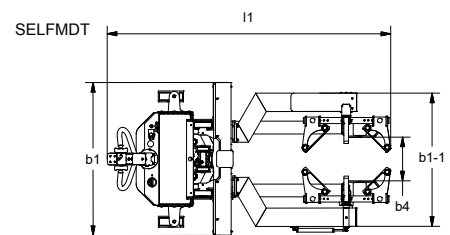
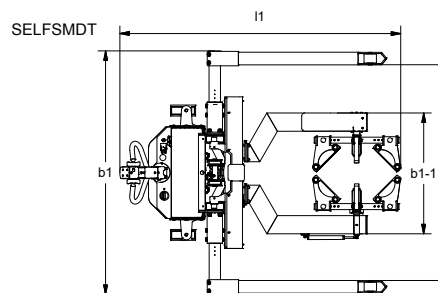
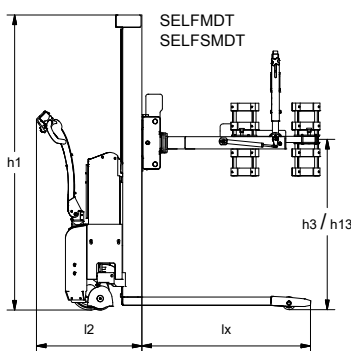

*We also offer tailor-made solutions.
Please ask for further information or visit our website www.logitrans.com*