

CX14 (II ED.) BASIC 1150X525

SMALL SIZE, GREAT MANOEUVRABILITY



CX14

The new CX14 electric pallet trucks are compact, lightweight and easy to use. They have been specifically designed for use in confined spaces within rail, shops, supermarkets and on-board delivery vehicles. These simple and efficient pallet trucks are built to last and are perfect for all your pedestrian material handling needs. They are available in four different versions: BASIC, PLUS AGM, EVO AGM and EVO Li-ION (Lithium batteries).

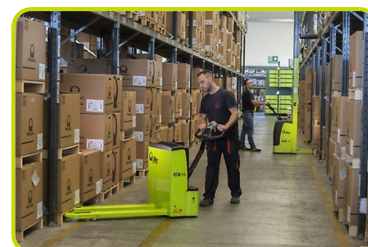

BASIC VERSION

The BASIC version is equipped with:

- Starting type battery
- Tiller made with metal tube and ergonomic fingertip controls
- Reliable DC drive system

A configuration that offers best value for money.



MANOEUVRABILITY

- Short chassis dimension (L2 = 410 mm) to offer improved manoeuvrability in confined spaces.
- Compact design perfect for working in narrow areas and corridors, featuring a tighter turning radius (Wa = 1345 mm) for faster pinwheeling and easier navigation in congested spaces.
- Smooth rounded fork tips and entry/exit rollers to optimize pallet handling.



RELIABILITY

- Robust frame (metal motor wheel protection 6 mm thick) designed to guarantee maximum durability and resistance to torsion and heavy loads.
- Battery discharge indicator to allow easy management.
- Easy access to electrical components for maintenance.



PRODUCTIVITY

- Strong ABS cover with storage tray on top, easily removable for simple access to batteries and key components speeding-up maintenance operations.
- Easy access to the motorwheel components through dedicated inspection opening.
- Schuko plug with spiral cable and on board battery charger.



INTELLIGENT TILLER

- Ergonomic tiller designed for both left and right handed operation.
- Butterfly valves for traction control.
- Safety push button with warning buzzer.
- Turtle function for moving in tight areas with the handle in vertical position while remaining almost within the profile of the machine.



ON-BOARD BATTERY CHARGER

Built-in battery charger provides a convenient charging solution and eliminates the need to remove the battery from the machine.



TRACTION & SAFETY

Traction is granted by the biggest heavy-duty stabilizer wheels (100x40 mm) in the category, with heavy duty spring. All linkage connections done through bushings that increase stability and durability.

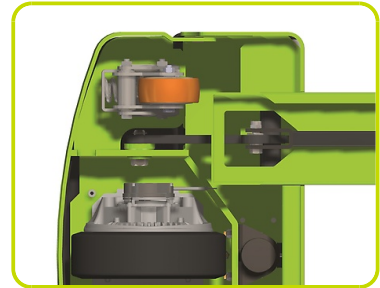

ROLLERS

Standard configuration provided with single polyurethane rollers. Available tandem rollers as optional.



Description

1.1 Manufacturer			PR INDUSTRIAL
Lift			Electric
1.3 Drive			Electric
1.4 Operator type			Pedestrian
1.5 Load capacity	Q	Kg	1400
1.6 Load centre distance	c	mm	600
1.8 Load axle to end forks	x	mm	935
1.9 Wheel base	y	mm	1196

Weights

2.1 Service weight (battery included)		Kg	223
2.2 Axle load, laden rear		Kg	1042
2.2 Axle load, laden front		Kg	581
2.3 Axle load, unladen front		Kg	186
2.3 Axle load, unladen rear		Kg	38

Tyres/Chassis

3.1 Tyres: front wheels			RUBBER
3.1 Tyres: stabilizers wheels - Front			POLY.C.
3.1 Tyres: rear wheels			POLY.C.
3.2 Tyre size: Steering wheels - Width		mm	76
3.2 Tyre size: Steering wheels - Diameter		mm	250
3.3 Tyre size: Load rollers - Diameter		mm	82
3.3 Tyre size: Load rollers - Width		mm	80
3.4 Tyre size: stabilizers wheels front - Diameter		mm	100
3.4 Tyre size: stabilizers wheels front - Width		mm	40
3.5 Tyre size: rear wheels - Q.ty (X=driven)		nr	2
3.5 Tyre size: front wheels - Q.ty (X=driven)		nr	1x
3.6 Tread, front	b10	mm	530
3.7 Tread, rear	b11	mm	375

Dimensions

4.4 Lift height	h3	mm	115
4.9 Height of tiller in drive position max	h14	mm	1230
4.9 Height of tiller in drive position min	h14	mm	730
4.15 Height, lowered	h13	mm	85
4.19 Overall length	l1	mm	1560
4.20 Length to face of forks	l2	mm	410
4.21 Overall width	b1	mm	720
4.22 Fork dimensions - Thickness	s	mm	55
4.22 Fork dimensions - Width	e	mm	150
4.22 Fork dimensions - Length	l	mm	1150
4.25 Distance between fork arms	b5	mm	525
4.32 Ground clearance, centre of wheelbase	m2	mm	30
4.34 Aisle width	Ast	mm	1810
4.35 Turning radius	Wa	mm	1345

Performance data

5.1 Travel speed laden	Km/h	4.4
5.1 Travel speed unladen	Km/h	4.8
5.2 Lifting speed laden	m/s	0.03
5.2 Lifting speed unladen	m/s	0.04
5.3 Lowering speed laden	m/s	0.05
5.3 Lowering speed unladen	m/s	0.04
5.8 Max gradeability laden	%	5
5.8 Max gradeability unladen	%	10
5.10 Service brake		Electric

Electric motors

6.1 Drive motor power	kW	0.7
6.2 Lift motor power	kW	1.0
Battery Type	Tipo	Automotive (C20)
6.4 Battery voltage	V	24
6.4 Battery capacity, Min	Ah	70
6.4 Battery capacity, Max	Ah	70
6.5 Battery weight, Min	Kg	30
6.5 Battery weight, Max	Kg	30
6.6 Energy consumption according to VDI cycle	kWh/h	0.25
8.4 Sound level at driver's ear	dB(A)	59

Integrated battery and battery charger

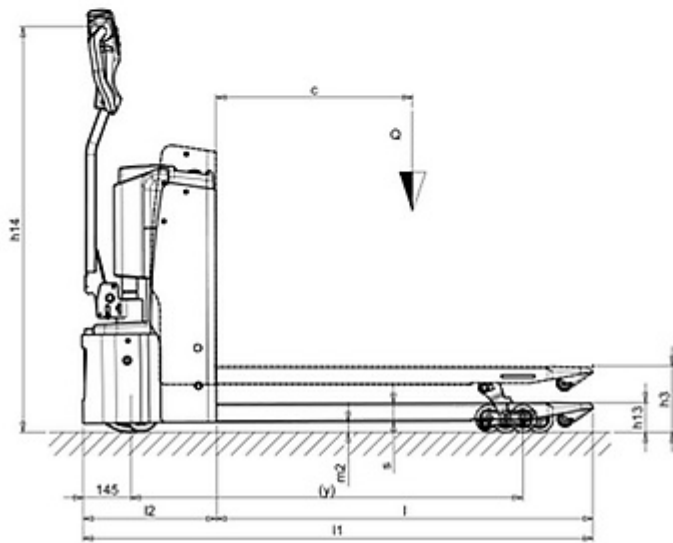
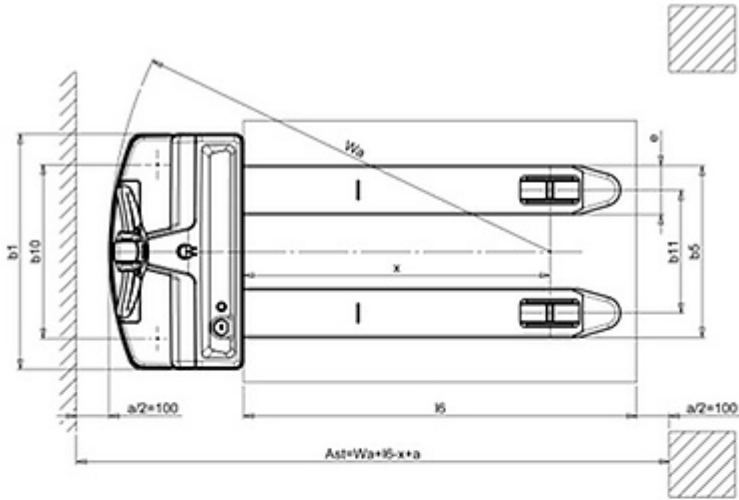

The information is aligned with the Data file at the time of download. Printed on 05/03/2019 (ID 8985)

©2019 | PR INDUSTRIAL s.r.l. | All rights reserved | Image shown may not reflect actual package. Specifications subject to change without notice

