

GS BASIC 22S2 1000X525

Entry level hand pallet truck (2.200 kg)



GS BASIC

The GS Basic pallet truck is the entry model of the Lifter hand pallet truck range, featuring reliability and solidness at competitive pricing.



HYDRAULIC UNIT

Resistant and reliable one piece cast iron pump, worked with numerical control machine, including:

- Maximum pressure valve: safety device that ensures the transpallet against overloads. When the pressure inside the hydraulic circuit exceeds the set calibration value according to the maximum nominal flow, the valve automatically locks the forks.
- ON/OFF lowering valve



STANDARD CONFIGURATION

- Nylon - Poly 45 steering wheels
- Nylon rollers
- 2 Curves handle with all the controls (lowering / drive position / lifting) available in a single lever for simple and safe control



VARNISHING

Following an appropriate conditioning operation the frame is varnished with polyester powder at a temperature of 250° to guarantee maximum resistance to wear and atmospheric agents.



OPTIONAL CONFIGURATION

- Nylon steering wheels
- Nylon - Poly 55 steering wheels
- Aluminium - Rubber steering wheels



- Polyurethane rollers



- Manual control brake. The brake of the pallet truck, available with rubber steering wheels, is adjustable through the tiller lever to ensure safe use on slopes and ramps. The locking function makes it possible to park the pallet truck even on slopes without rolling away.



Description

1.1 Manufacturer			LIFTER
1.3 Drive			Manual
1.4 Operator type			Pedestrian
1.5 Load capacity	Q	Kg	2200
1.6 Load centre distance	c	mm	500
1.8 Load axle to end forks	x	mm	782
1.9 Wheel base	y	mm	1042

Weights

2.1 Service weight		Kg	58
2.2 Axle load, laden rear		Kg	1582
2.2 Axle load, laden front		Kg	676
2.3 Axle load, unladen rear		Kg	20
2.3 Axle load, unladen front		Kg	38

Tyres/Chassis

3.1 Tyres: front wheels			POLY.I./ NYLON
3.1 Tyres: rear wheels			NYLON
3.2 Tyre size: Steering wheels - Diameter		mm	200
3.2 Tyre size: Steering wheels - Width		mm	45
3.3 Tyre size: Load rollers - Diameter		mm	82
3.3 Tyre size: Load rollers - Width		mm	82
3.5 Tyre size: rear wheels - Q.ty (X=driven)		nr	2
3.5 Rear balancing axle			No
3.6 Tread, front	b10	mm	155
3.7 Tread, rear	b11	mm	375

Dimensions

4.4 Lift height	h3	mm	115
4.9 Height of tiller in drive position max	h14	mm	1160
4.15 Height, lowered	h13	mm	85
4.19 Overall length	l1	mm	1400
4.20 Length to face of forks	l2	mm	400
4.21 Overall width	b1	mm	525
4.22 Fork dimensions - Thickness	s	mm	55
4.22 Fork dimensions - Width	e	mm	150
4.22 Fork dimensions - Length	l	mm	1000
4.25 Distance between fork arms	b5	mm	525
4.32 Ground clearance, centre of wheelbase	m2	mm	30
4.34 Aisle width	Ast	mm	1635
4.35 Turning radius	Wa	mm	1217

Performance data

5.2 Lifting speed laden	strokes	13
5.2 Lifting speed unladen	strokes	13

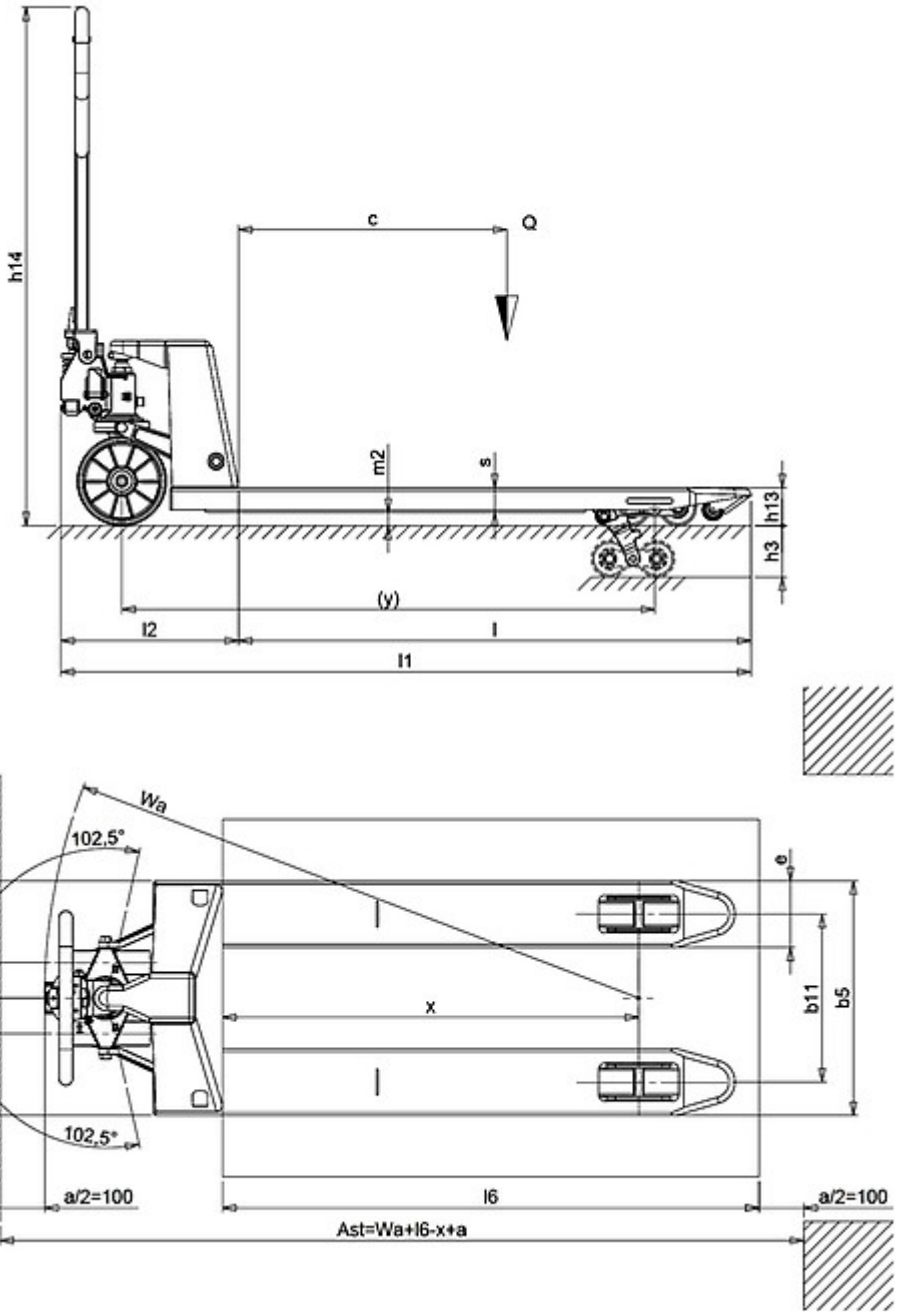

The information is aligned with the Data file at the time of download. Printed on 04/03/2019 (ID 523)

©2019 | PR INDUSTRIAL s.r.l. | All rights reserved | Image shown may not reflect actual package. Specifications subject to change without notice

